

# Flat Panel VMT

## Natural Stones & Natural Woods

1190X595x20/40 mm | 8 Panel Box  
Installation Manual

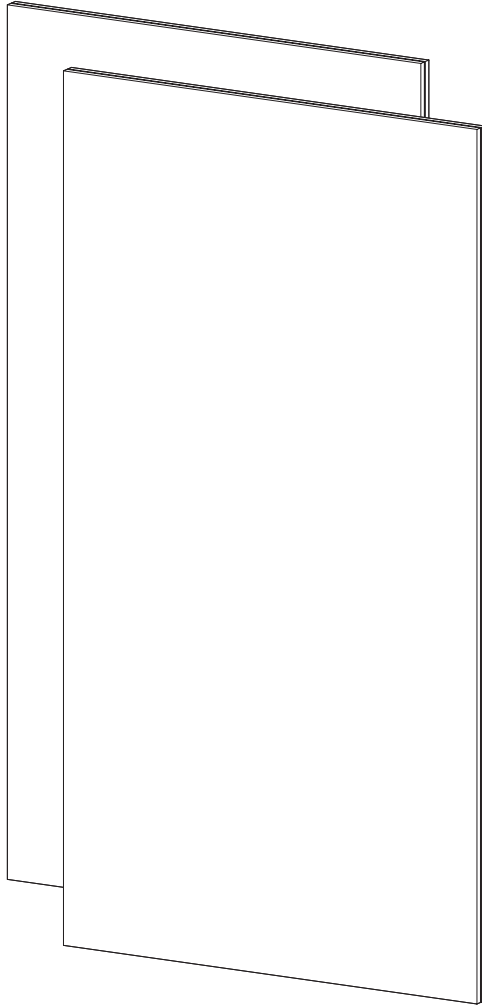

MATERIAL NEEDED

**Included**

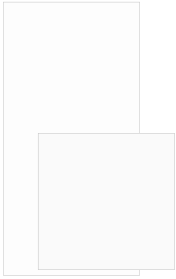

Flat Panel VMT



Velcro Stripes

**Not Included**

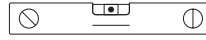

Level



Measuring Tape



Box Cutter

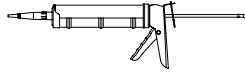

Glue

**Installation Option**

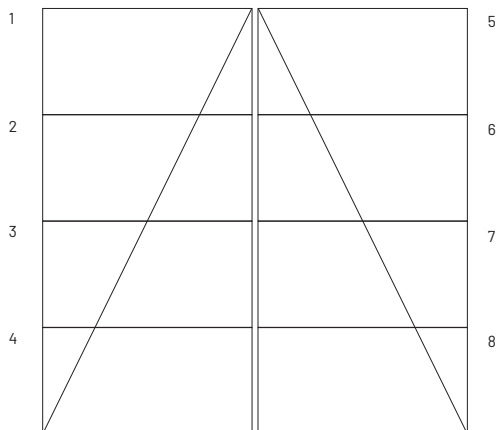
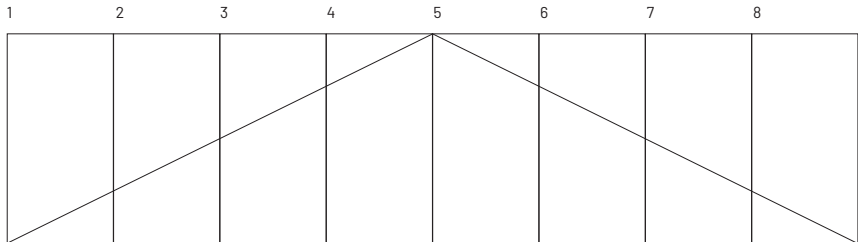

# Partial wall installation

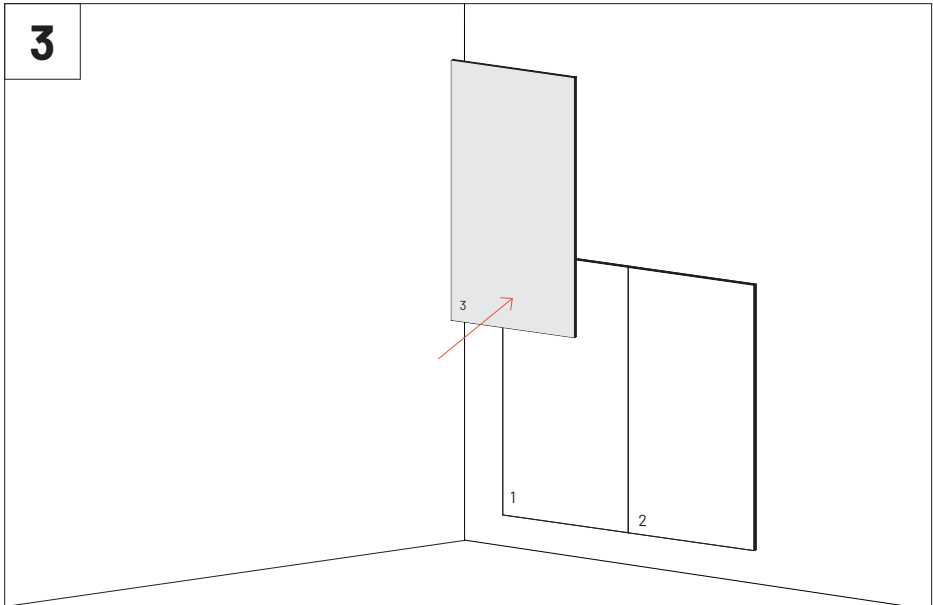
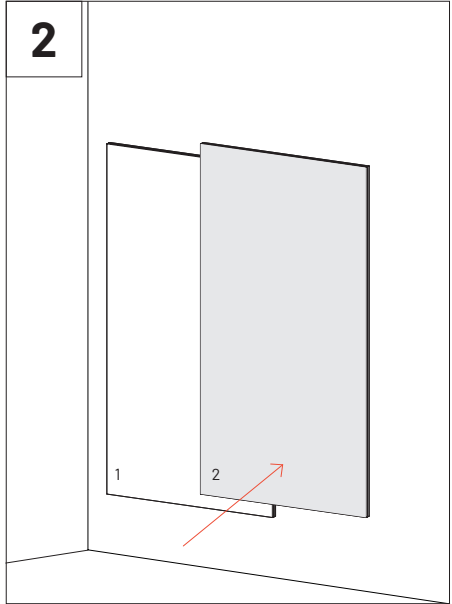
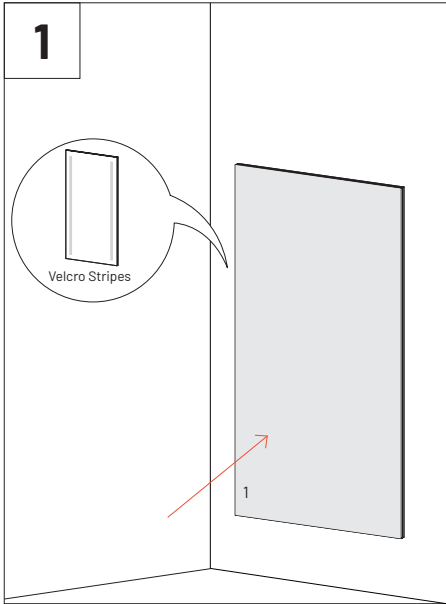

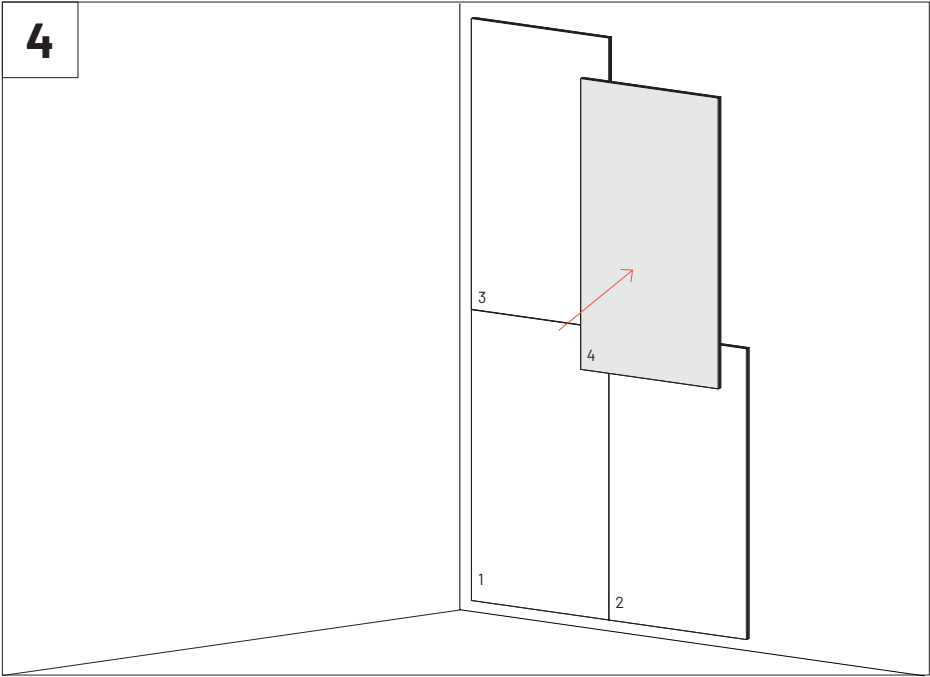

**Full wall installation**

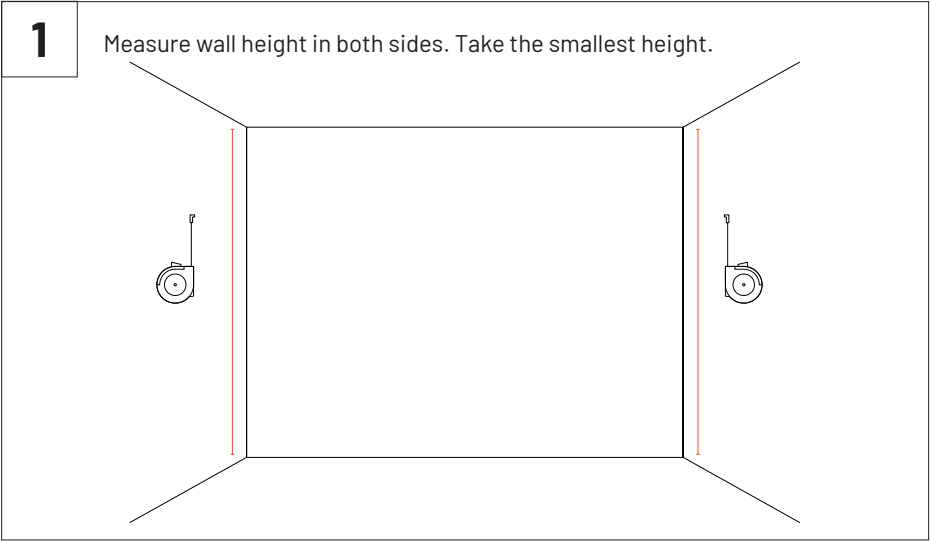

**2**

Based on the smallest height, calculate if it is necessary to cut one of the panels to fill the entire wall height. Check for continuity between panels before cutting.

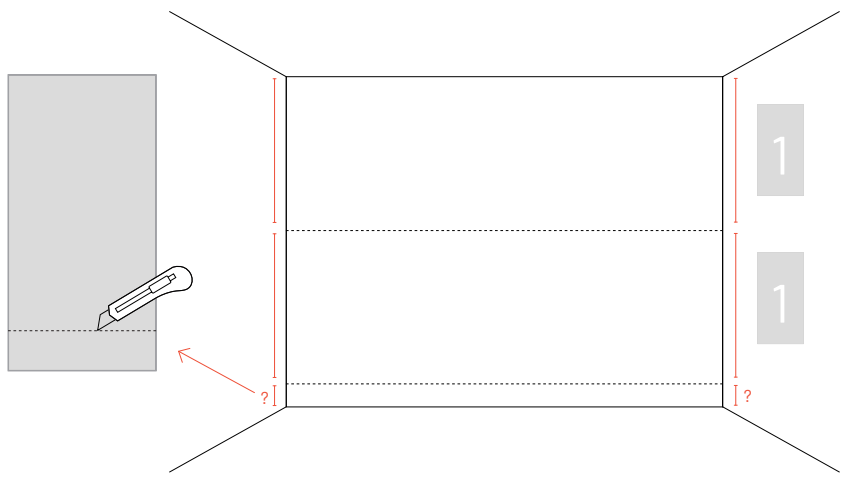

**3**

Glue the Velcro tape in the wall. It is recommended to use 2 stripes of Velcro per panel (included). You can also glue the panels directly to the wall with Flexi Glue Ultra

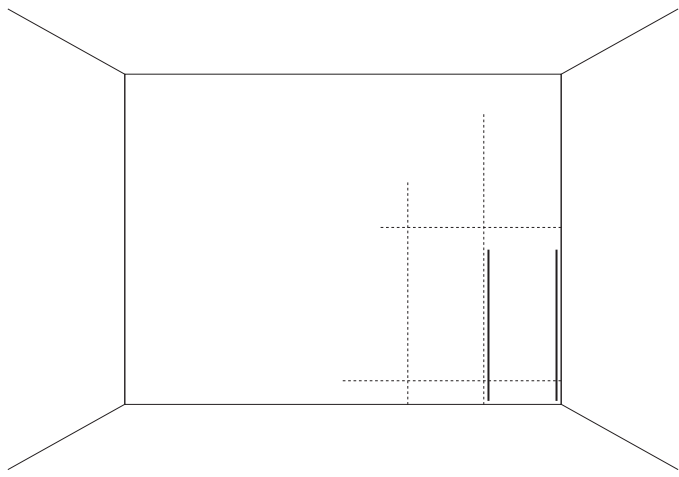

**4**

Start the installation from the bottom-right side (If cuted panels are going to be used it is recommended to start with these). Check if panels are leveled before proceeding to next row.

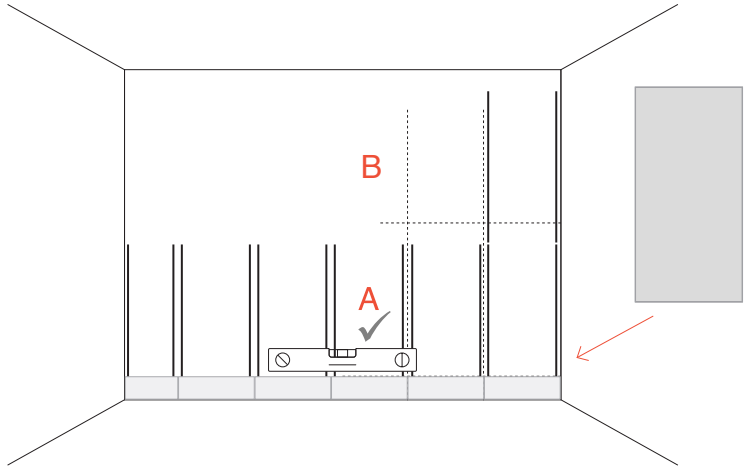
**5**

Install the remaining panels.

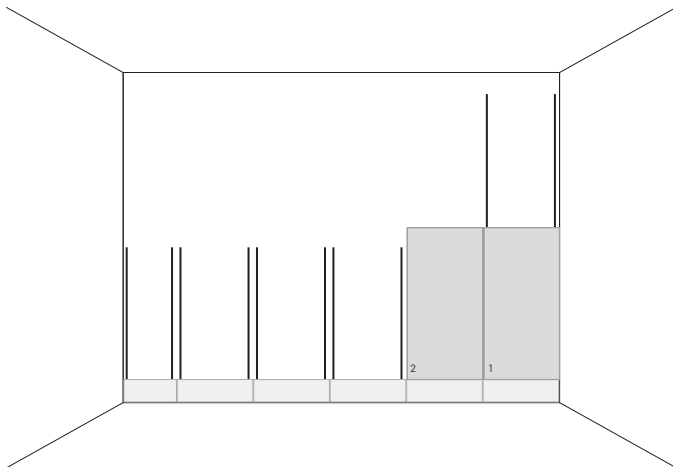

**6**

VMT boards can be installed vertically or horizontally, depending on the pattern and desired orientation.

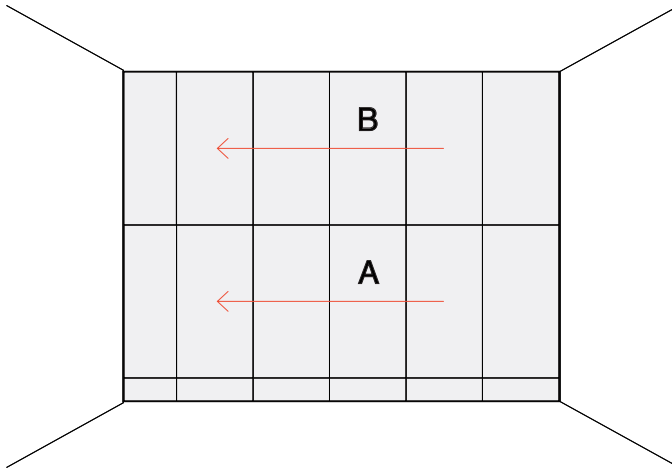

**!**

For the installation of Flat Panel VMT on the ceiling, we recommend using Flexi Glue Ultra.

Do not apply Flat Panel VMT behind radiators or too close to a heat source.

### **Main Office, R&D & Logistics**

Avenida do Pólo 3, N.º 159, Carvalhosa  
4590-137 Paços de Ferreira, Portugal

### **Office**

Rua Quinta do Bom Retiro N.º 16, Armazém 9  
2820-690 Charneca da Caparica, Portugal  
T (+351) 212 964 100

### **Info and Sales**

E [sales@vicoustic.com](mailto:sales@vicoustic.com)

[www.vicoustic.com](http://www.vicoustic.com)



© Vicoustic, 2021 | V8

No parts of this document might be copied and/or published without written consent of Vicoustic.